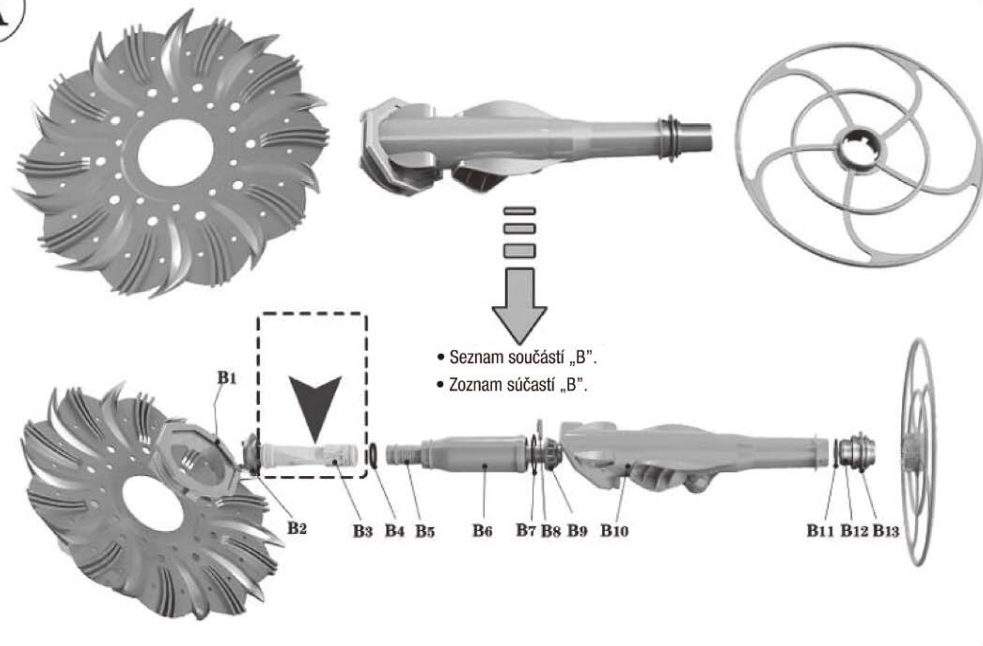
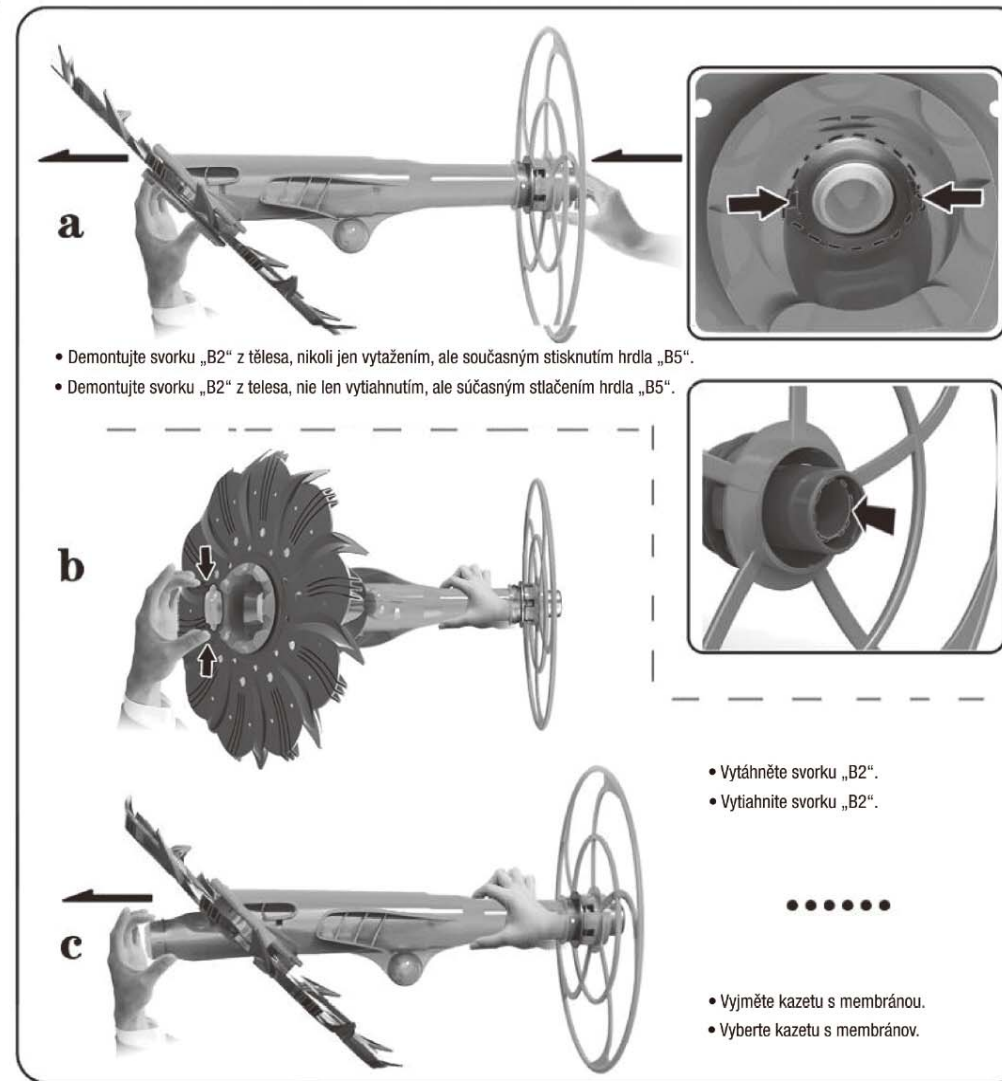
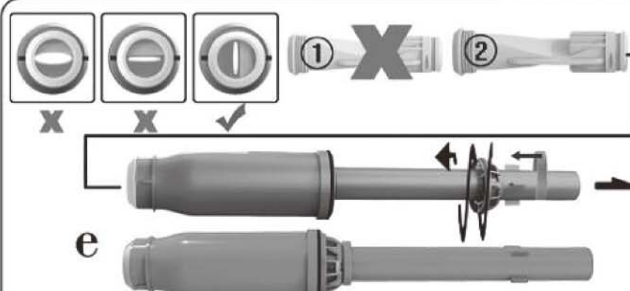
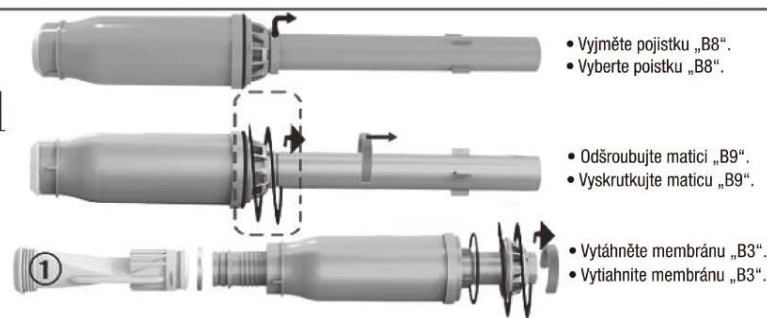

A

Vyměňte membránu následovně:
Vymeňte membránu nasledovne:

B**d**

• Nainštalujte novú membránu „2“, montáž zodpovedá vyššie uvedenému popisu v opačnom poradí.

• Nainštalujte novú membránu „2“, montáž zodpovedá vyššie uvedenému popisu v opačnom poradí.

• Nainštalujte díly vysavače níže uvedeným způsobem.

• Nainštalujte díly vysavača nižšie uvedeným spôsobom.

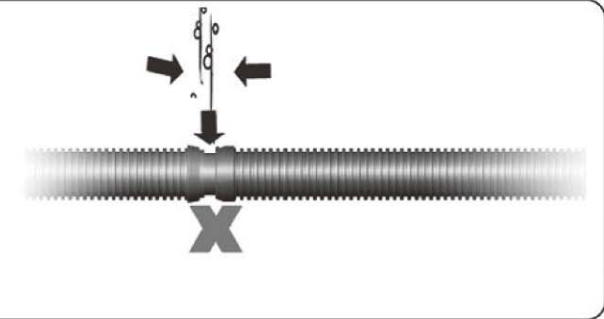
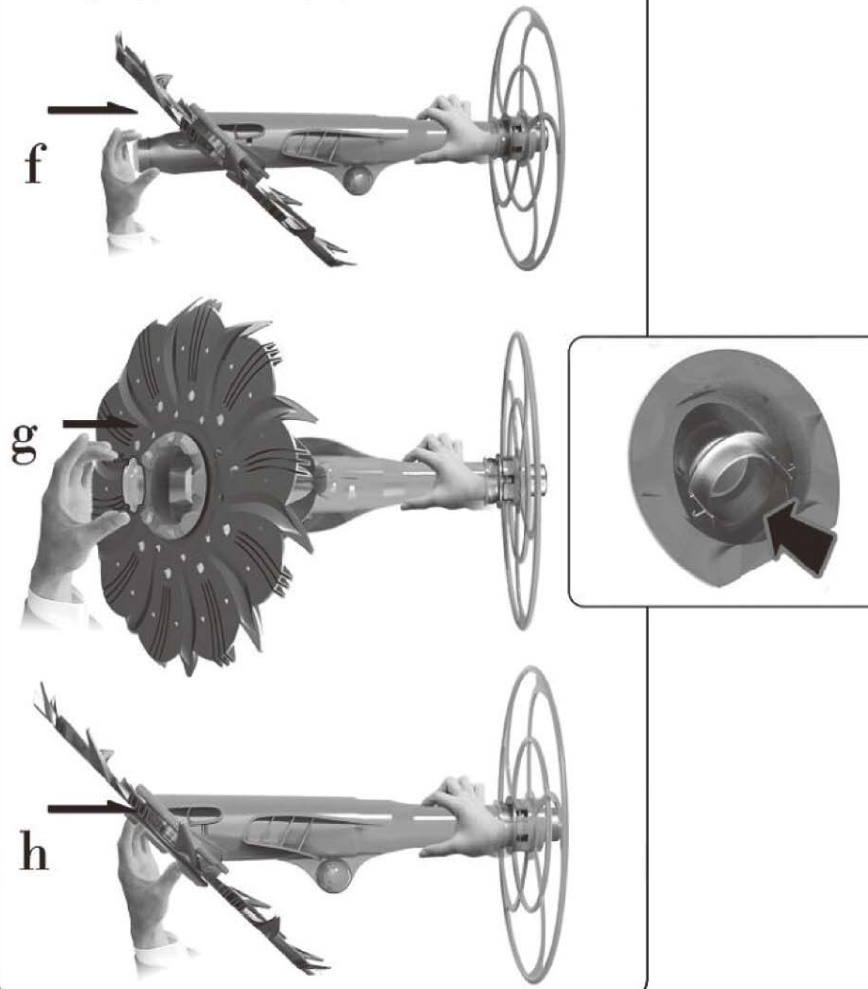

Min. 0,5HP/1000 galonů (3700 litrů)
Min. 0,5HP/1000 galónov (3700 litrov)

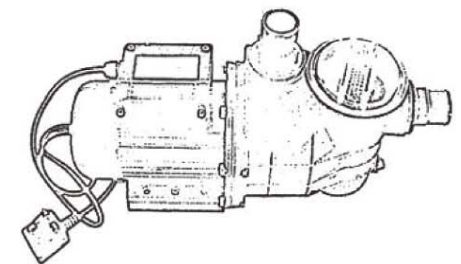

• Čerpadlo filtrace by mělo mít výkon min. 0,5 HP/3700 litrů za hodinu.

• Čerpadlo filtrácie by malo mať výkon min. 0,5 HP/3700 litrov za hodinu.

